



Runbar/ Palm Button Assemblies

(248) 356-2839

Stand mount or table top mount assemblies are ergonomically designed to provide safety and comfort

FEATURES

- Adjustable height stands available
- Table top assemblies available (no stands)
- 2-6 stations common configurations
- Custom colors available
- AC or DC voltages
- Built to customer wiring specifications
- Automotive standards followed
- Many connection options (receptacles, pigtails, plugs, hardwired)
- Various style of buttons available (push, ergonomic, touch-capacitive, LED, etc.)
- Variety of I/O (switches, lights, etc.)
- Use the 5000 series LED light for design consideration
- Design services available



COMMON EXAMPLE - Mechanical / Electrical

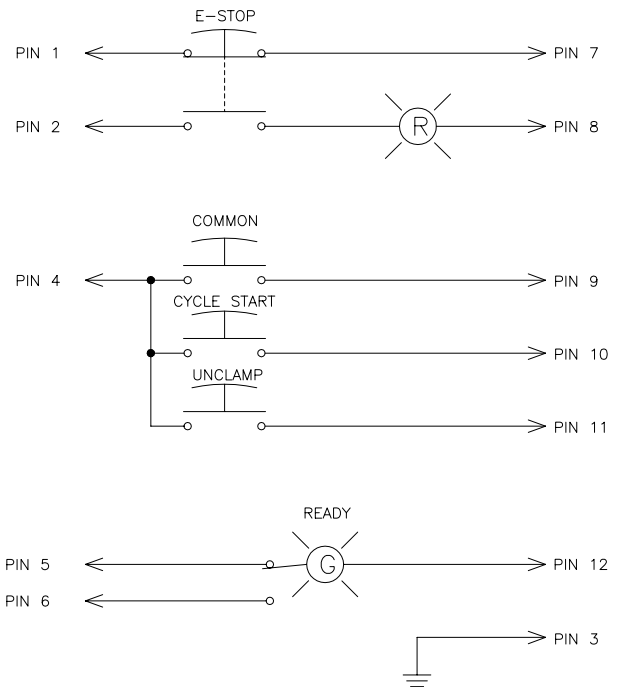
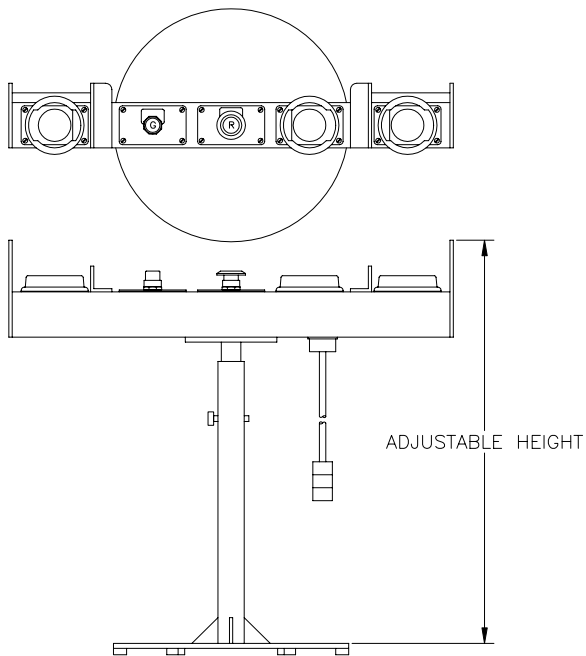

Notice: The information contained herein is, to the best of our knowledge, true, accurate and reliable. Since procedures and conditions under which these products may be used are beyond our control, no warranty, expressed or implied, is made to their performance.



Syndevco Inc. Sheet: 040120
 24205 Telegraph Rd - Southfield MI 48034
 Toll Free: (800) 356-2839 Local: (248) 356-2839 Fax: (248) 356-0928
 visit us at: www.syndevco.com



Runbar/ Palm Button Assemblies

ENCLOSURE OPTIONS

Built to Customer Specifications

Many additional options to choose from:

Number of Stations

- 6 Station
- 5 Station
- 4 Station
- 3 Station
- 2 Station

Electrical (side or bottom mount)

- Receptacle
- Pigtail
- Blunt (hardwire)

Mounting (table top or stand)

- Top
- Bottom

Stations

- Button type (See a Syndevco Rep for options)
- Blank plates for spare stations
- Indicator lamps, switches, etc. available

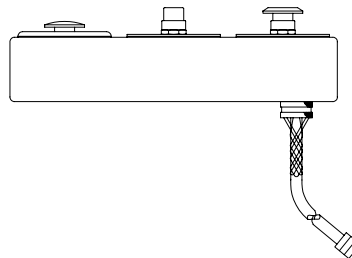
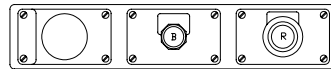
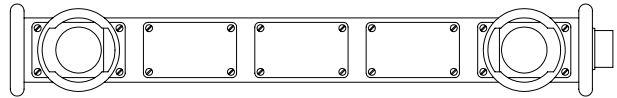

STAND OPTIONS and EXAMPLES

Customer Specs Welcome

3 leg Base
Quick Twist Height Adjust
Extended mount plate

Round Base
Pull Pin Height adjust
Standard mount plate

Round Cut Out Base
Pull Pin Height adjust
Standard mount plate

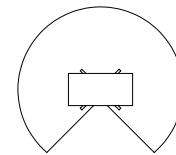
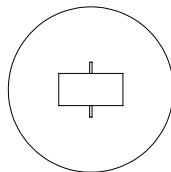
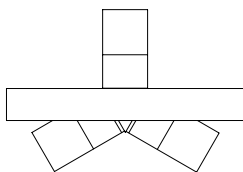
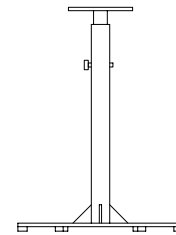
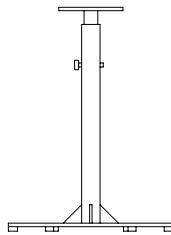
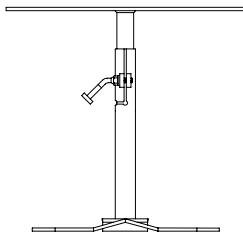

Notice: The information contained herein is, to the best of our knowledge, true, accurate and reliable. Since procedures and conditions under which these products may be used are beyond our control, no warranty, expressed or implied, is made to their performance.



Syndevco Inc.

Sheet: 040120

24205 Telegraph Rd - Southfield MI 48034

Toll Free: (800) 356-2839 Local: (248) 356-2839 Fax: (248) 356-0928

visit us at: www.syndevco.com